

# Data Sheet



Article number: 0102049

Description: Retaining ring J32 DIN472  
Spring steel

## Measures

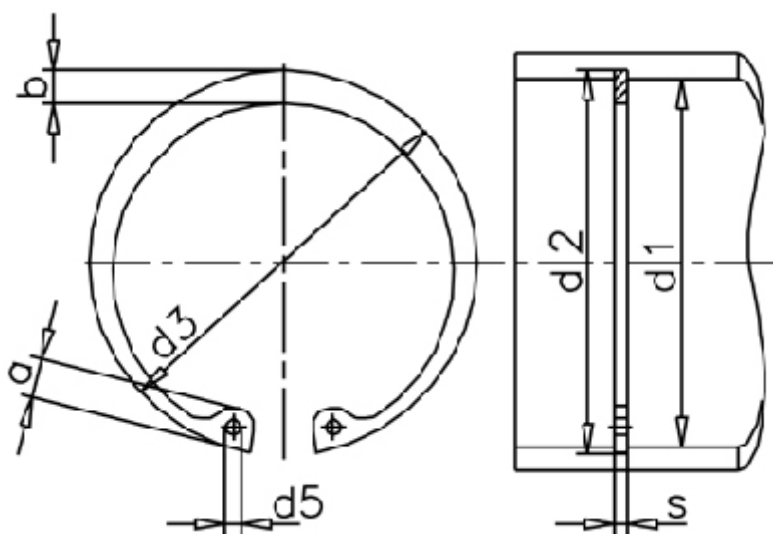

a max	= 5.4	FN kN	= 14.60	t	= 0.85
AN mm <sup>2</sup>	= 87.9	FRg kN	= 4.7	tol	= +0,25
b	= 3.2	FR kN	= 13.8	tol	= +0,50-0,25
d1	= 32	g	= 1.0	tol	= -0.06
d2	= 33.7	K kN-mm	= 26.6	Tong	= ZGJ-2
d3	= 34.40	m min	= 1.30	Weight kg/1000	= 2.21
d5 min	= 2.5	Nominal drive	= 2.6		
Description = J 32		s	= 1.20		